

# *Western Electric*

## 306A Vacuum Tube

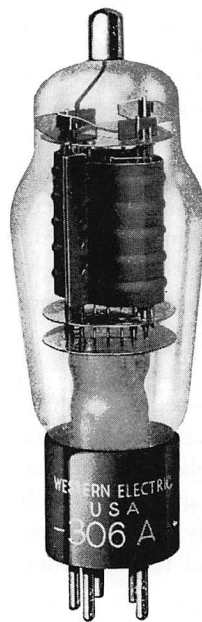

**Classification—Moderate-power, filamentary, suppressor-grid pentode**

The 306A tube may be used at relatively high radio frequencies. The suppressor grid is permanently connected to the center point of the filament within the bulb.

**Applications**

- Audio-frequency amplifier in positions where power outputs of approximately 8 watts or less are required.
- Radio-frequency amplifier where high overall voltage amplification is not required.
- Oscillator.
- Modulator and frequency multiplier.

**Dimensions—**Dimensions, outline diagrams of the tube and base, and the arrangement of the electrode connections to the base terminals are shown in Figures 1 and 2.

**Base—**Medium, five-pin thrust type with bayonet pin. Small, metal cap control-grid terminal at the top of the bulb.

**Socket—**Standard, five-contact type, such as the Western Electric 141A socket.

**Mounting Positions**—Either vertical or horizontal. If mounted in a horizontal position, the plane of the filament, which is indicated in Figure 2, should be vertical.

**Average Direct Interelectrode Capacitances**

Control grid to plate . . . . .	0.35 $\mu\mu\text{f.}$
Control grid to filament, screen grid and suppressor grid . . . . .	13 $\mu\mu\text{f.}$
Plate to filament, screen grid and suppressor grid . . . . .	13 $\mu\mu\text{f.}$

**Filament Rating**

Filament voltage . . . . .	2.75 volts, a.c. or d.c.
Nominal filament current . . . . .	2.0 amperes

The filament of this tube is designed to operate on a voltage basis and should be operated at as near the rated voltage as is practicable.

**Filament Connection**—The suppressor grid and the center point of the filament are connected to a pin in the base. When alternating current is used for heating the filament, the grid and plate returns may be connected to this point instead of to a center tap of the filament heating transformer secondary. When the tube is used in very high-frequency circuits, 20 megacycles or above, the center point should be connected through low-impedance by-pass condensers to the two end points of the filament in order to minimize the effective filament inductance.

**Characteristics**—Plate current and screen-grid current characteristics for a typical 306A tube are shown in Figures 3 and 4, respectively, as functions of control-grid voltage for several values of screen-grid and plate voltage. The plate voltage for these characteristics is equal to the screen-grid voltage. Plate current and screen-grid current characteristics are shown as functions of plate voltage in Figures 5 and 6, respectively, for a screen-grid voltage of 300 volts. Corresponding amplification factor, plate resistance, and transconductance characteristics are shown in Figures 7, 8, and 9, respectively.

The characteristics above and the tabulated values and output curves to follow are for direct-current filament supply with the grid and plate voltages measured from the negative end of the filament. When alternating-current filament supply is used, approximately the same characteristics, tabulated values, and output curves are applicable if 1.6 is added to the numerical value of each control-grid voltage.

**Limiting Conditions for Safe Operation**

Maximum plate voltage . . . . .	300 volts
Maximum screen-grid voltage . . . . .	300 volts
Maximum instantaneous control-grid potential on positive swing of input voltage . . . . .	+30 volts
Maximum plate current for audio-frequency amplifier applications	60 milliamperes
Maximum plate current for applications other than audio-frequency amplification . . . . .	50 milliamperes
Maximum plate dissipation . . . . .	15 watts
Maximum screen-grid current . . . . .	20 milliamperes
Maximum control-grid current . . . . .	7 milliamperes

If a tube has been operating for more than one hour in a circuit in which its control-grid potential is continuously negative, as, for example, in an audio-frequency amplifier circuit, it should not thereafter be operated in an oscillator, Class C amplifier, or other circuit in which the control-grid potential is carried positive. If, however, the filament emission has been impaired by not observing this precaution, it can usually be restored by aging the tube for 24 hours in whichever type of circuit is chosen for subsequent operation.

**Operating Conditions and Output**

**Class A—**Audio-Frequency Amplifier or Modulator—Permissible operating screen-grid and control-grid voltages for audio-frequency amplifier applications are included within the area, ABCDE, in Figure 3. Amplification factor, plate resistance, transconductance, and performance data are given in the table below for a number of typical operating conditions represented by selected points within this area. Less severe operating conditions should be selected in preference to maximum operating conditions wherever possible. The life of the tube at maximum conditions may be shorter than at less severe conditions.

The performance data include the fundamental power output in watts and the maximum level of any harmonic in db below the fundamental corresponding to the indicated values of load resistance and input voltage. The input for each operating condition has been so chosen that its peak value is numerically equal to the control grid-bias, and the load resistance has been so chosen that for the range of inputs between zero and this maximum value, the maximum levels of the second and third harmonics are equal.

Plate Voltage	Screen-Grid Voltage	Control-Grid Bias	Plate Current	Screen-Grid Current	Amplification Factor	Plate Resistance	Trans-conductance	Load Resistance	Input Voltage	Power Output	Maximum Harmonic Level
Volts	Volts	Volts	Milli-amperes	Milli-amperes		Ohms	Micro-mhos	Ohms	Peak Volts	Watts	db
200	200	-12	32	7.0	260	70000	3700	4600	12	3.0	24.5
250	250	-15	43	9.5	250	62000	4050	3800	15	5.0	24.5
*300	300	-20	48	10.0	290	70000	4150	4100	20	8.8	21.0

\*Maximum operating conditions

Curves showing the variation of power output and second and third harmonic levels with input voltage for several values of load resistance are shown in Figures 10, 11 and 12, respectively, for a typical operating condition. Figures 13, 14 and 15 extend the data given in the last four columns of the table to other maximum harmonic levels. Each ordinate in Figure 13 gives the maximum power output obtainable from the tube at the indicated operating condition, where both the second and third harmonics are limited to the level given by the corresponding abscissa. The values of input voltage and load resistance which are required at each point are given in Figures 14 and 15, respectively.

**Class C—**Radio-Frequency Amplifier—Plate and Screen Modulated. Typical operating conditions and output.

Direct plate voltage . . . . .	300 volts
Direct screen-grid voltage (approximate) . . . . .	180 volts
Screen-grid circuit resistance . . . . .	8000 ohms
Total control-grid bias (approximate) . . . . .	- 50 volts
Control-grid circuit resistance . . . . .	10000 ohms
Fixed control-grid bias . . . . .	- 20 volts
R-F control-grid driving voltage . . . . .	70 peak volts
Direct plate current . . . . .	36 milliamperes
Direct screen-grid current . . . . .	15 milliamperes
Direct control-grid current . . . . .	3 milliamperes
Effective load resistance . . . . .	4500 ohms
Carrier power output . . . . .	7 watts
Power output on a-f peaks . . . . .	28 watts

For this type of operation, the modulating voltage is applied to the plate through the r-f coil, and to the screen grid through the 8000 ohm screen-grid resistance. No by-pass condenser is used across this resistance so that the actual modulating voltage applied to the screen grid is somewhat lower than that applied to the plate. The by-pass condenser between the screen grid and filament should be as small as practicable to avoid by-passing the higher modulating frequencies.

**High Frequency Ratings**

The 306A tube may safely be used at full ratings for operating frequencies up to 50 megacycles and at reduced ratings up to 70 megacycles. Ratings for these two frequencies are as follows:

	<u>50</u> Megacycles	<u>70</u> Megacycles
Maximum direct plate voltage.....	300	225 volts
Maximum direct plate current.....	50	50 milliamperes

For frequencies between these two values proportionate ratings are applicable. The object in reducing the ratings is to limit the charging currents and dielectric losses, which dissipate considerable heat in the leads and glass of the tube at high frequencies.

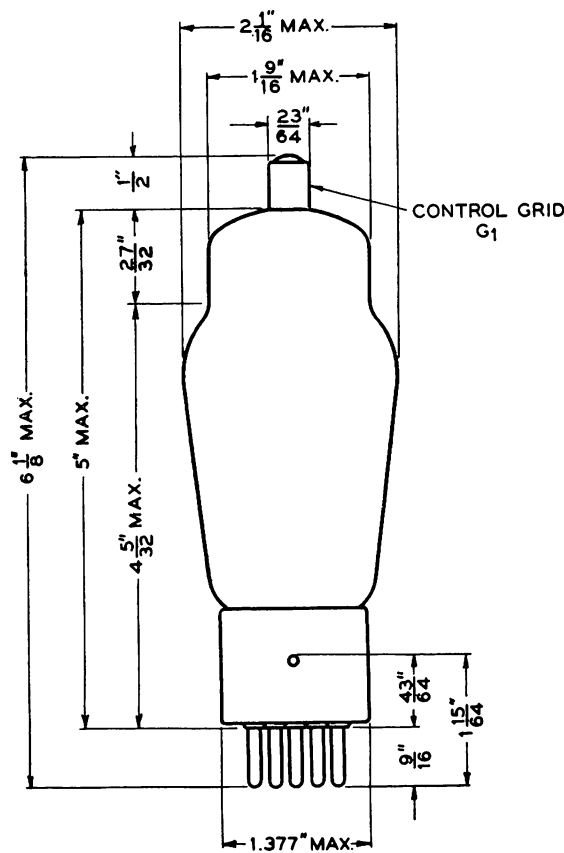

FIG. 1

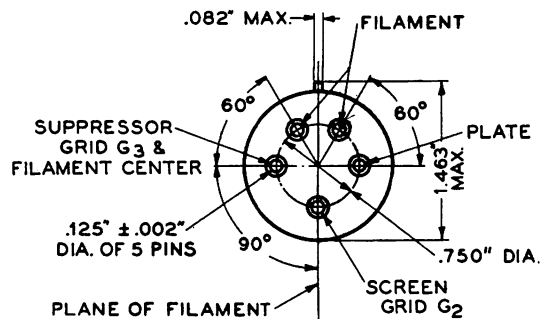

FIG. 2

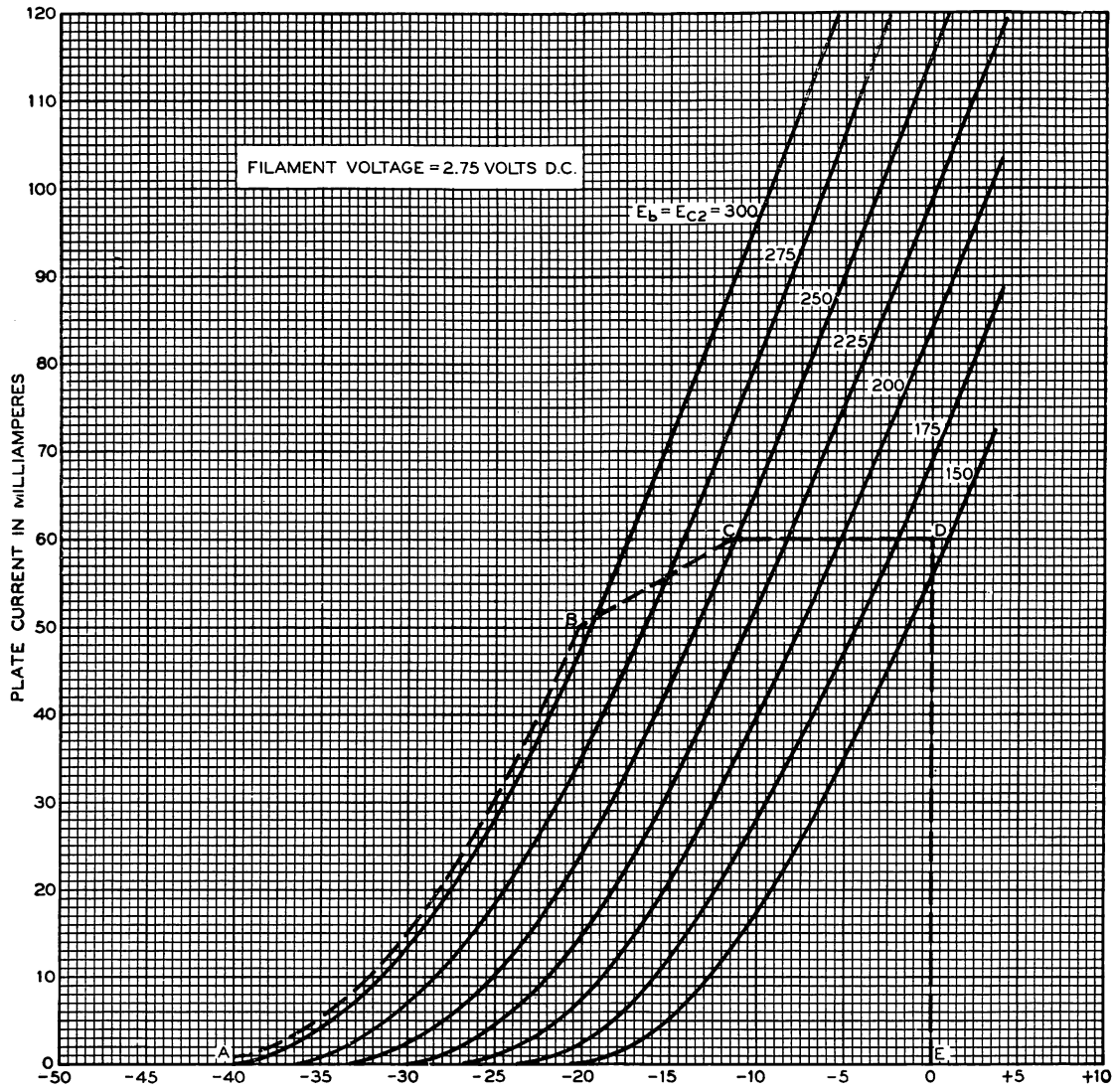

FIG. 3

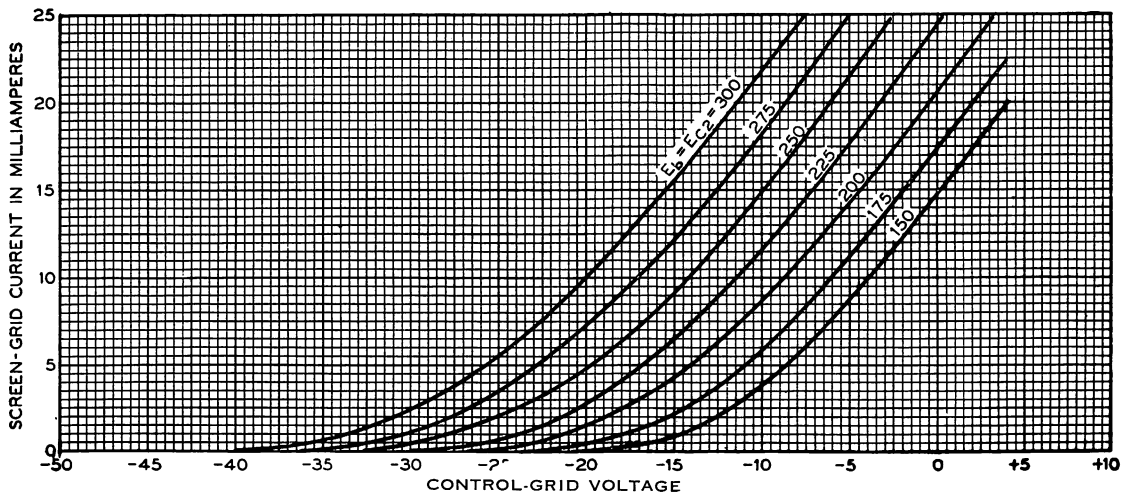

FIG. 4

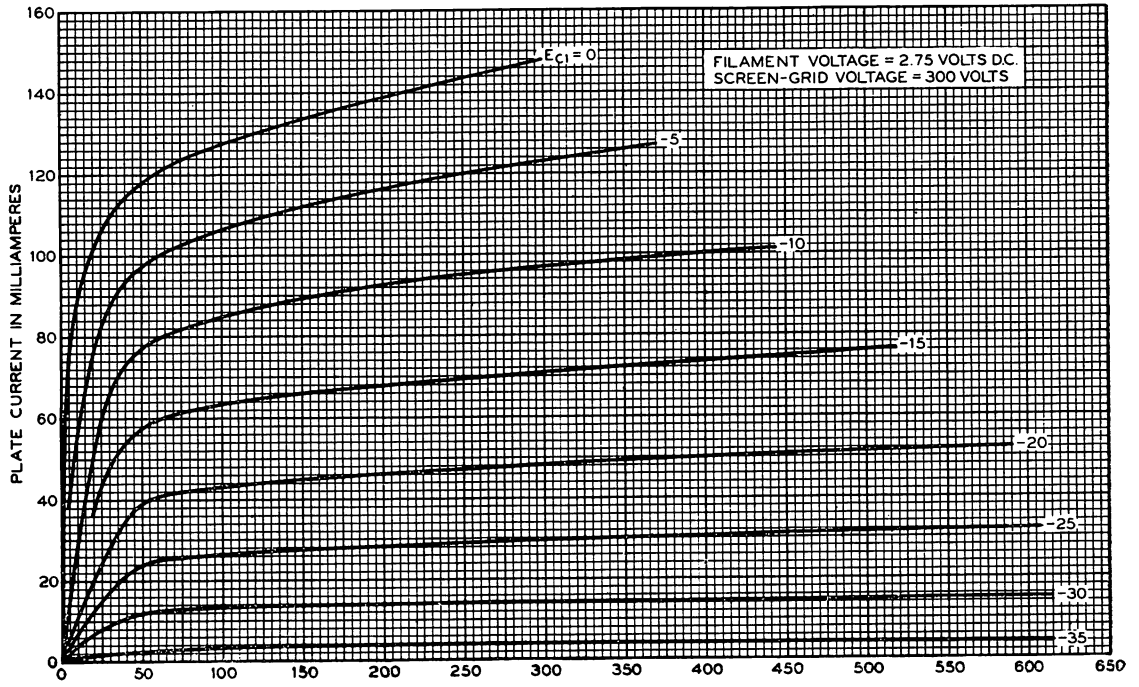

FIG. 5

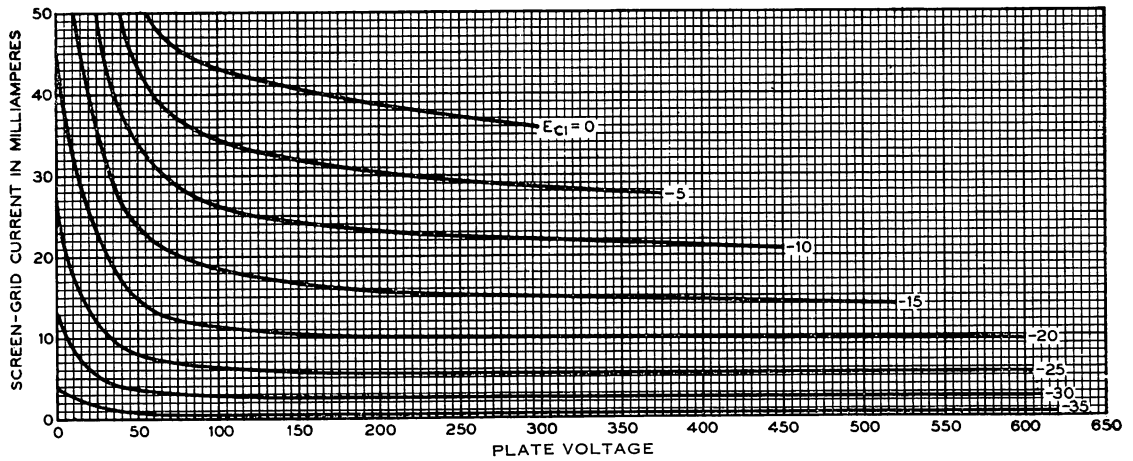

FIG. 6

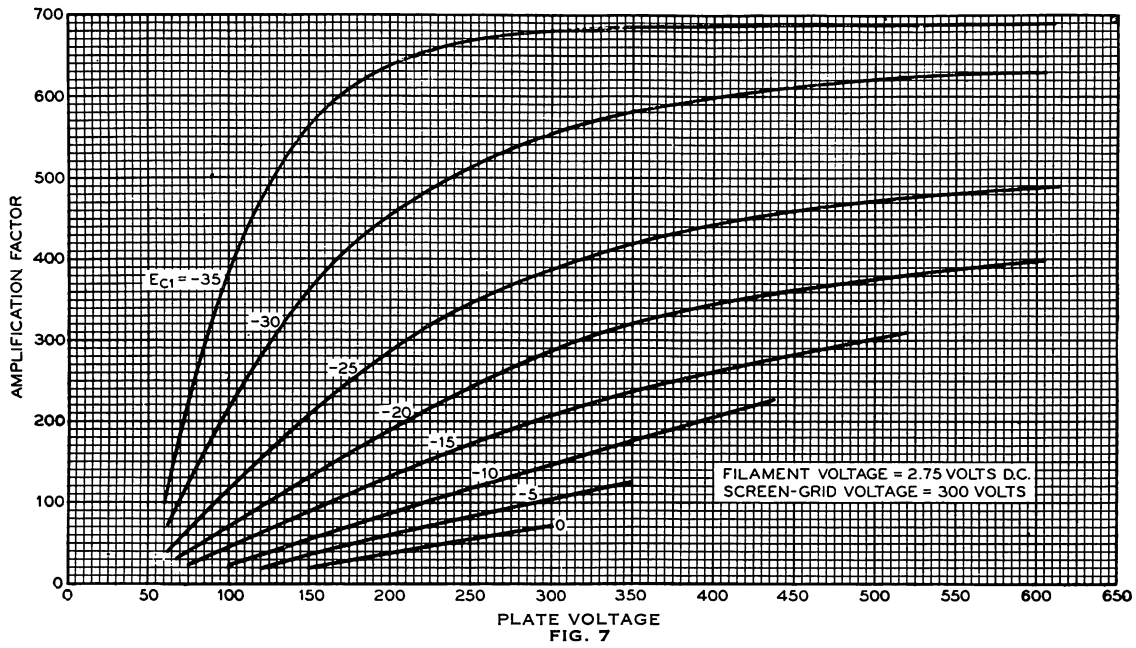

FIG. 7

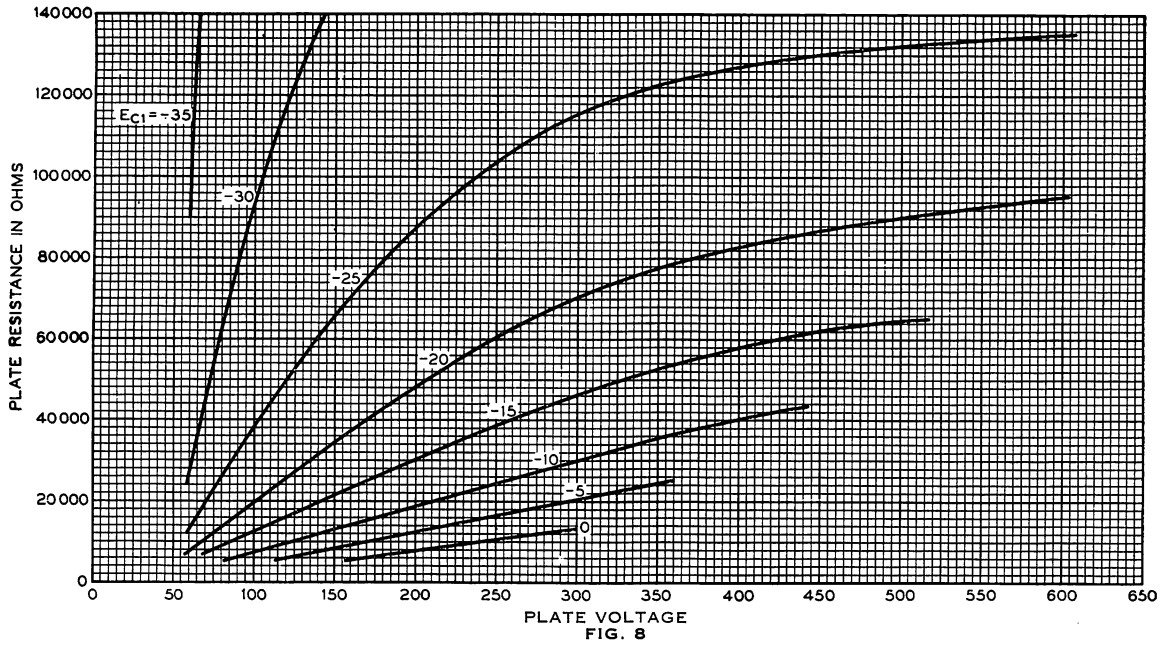

FIG. 8

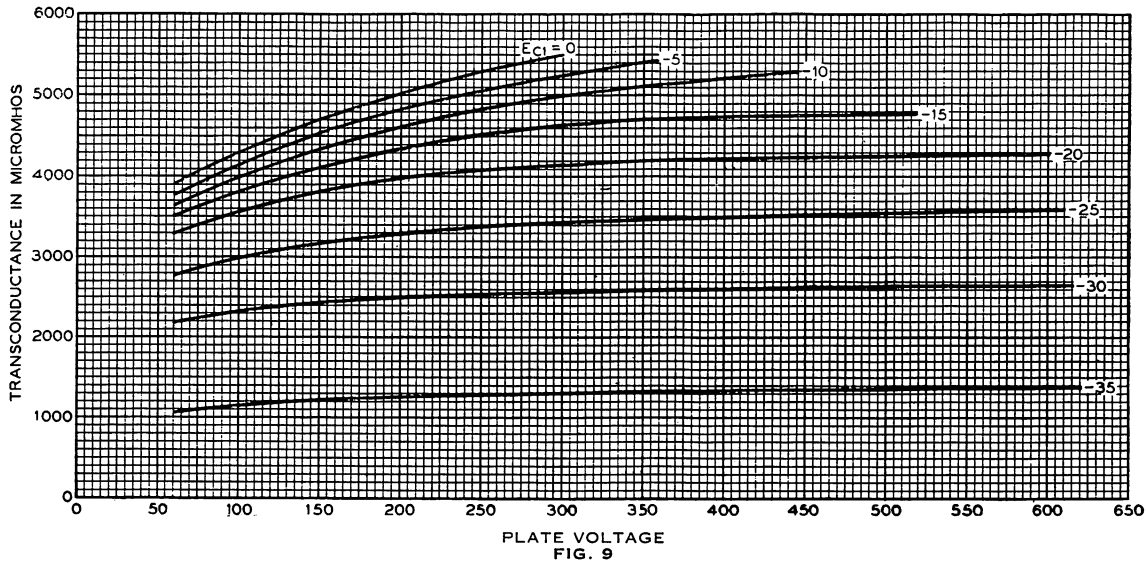
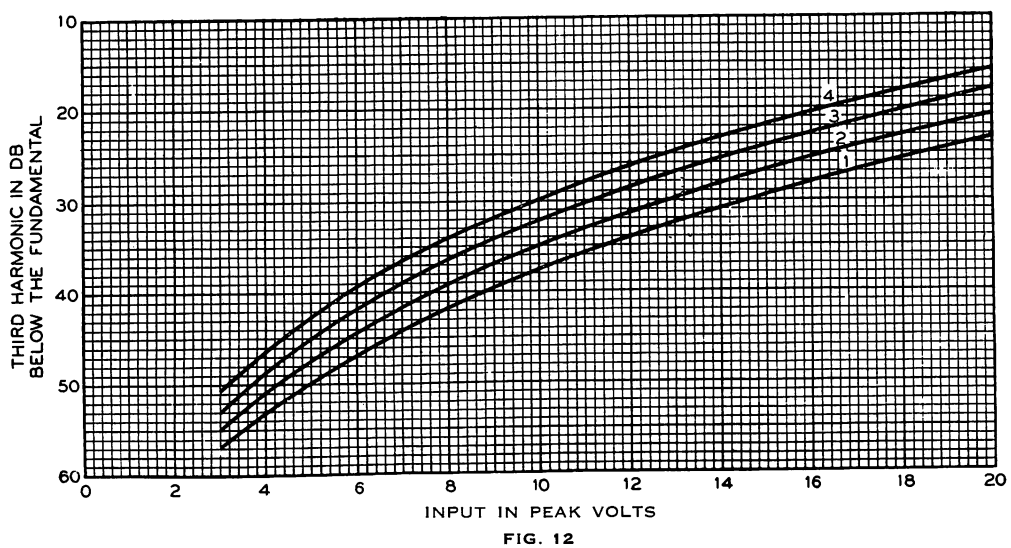
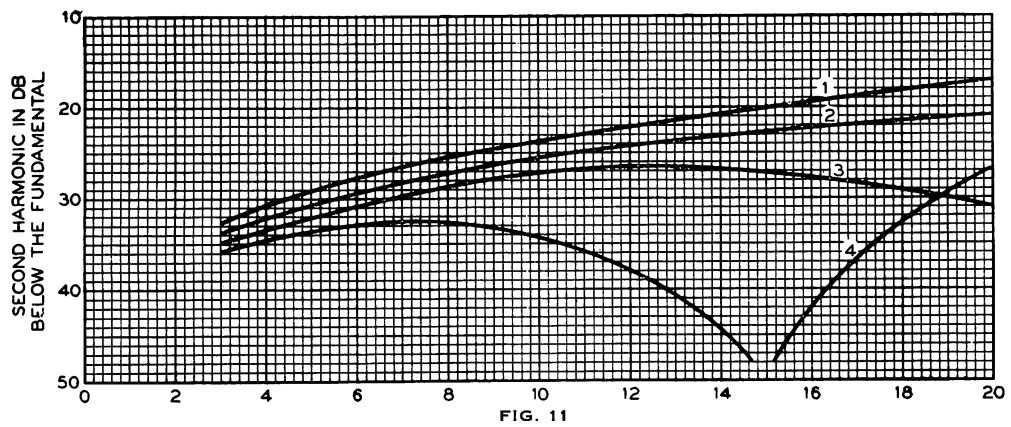
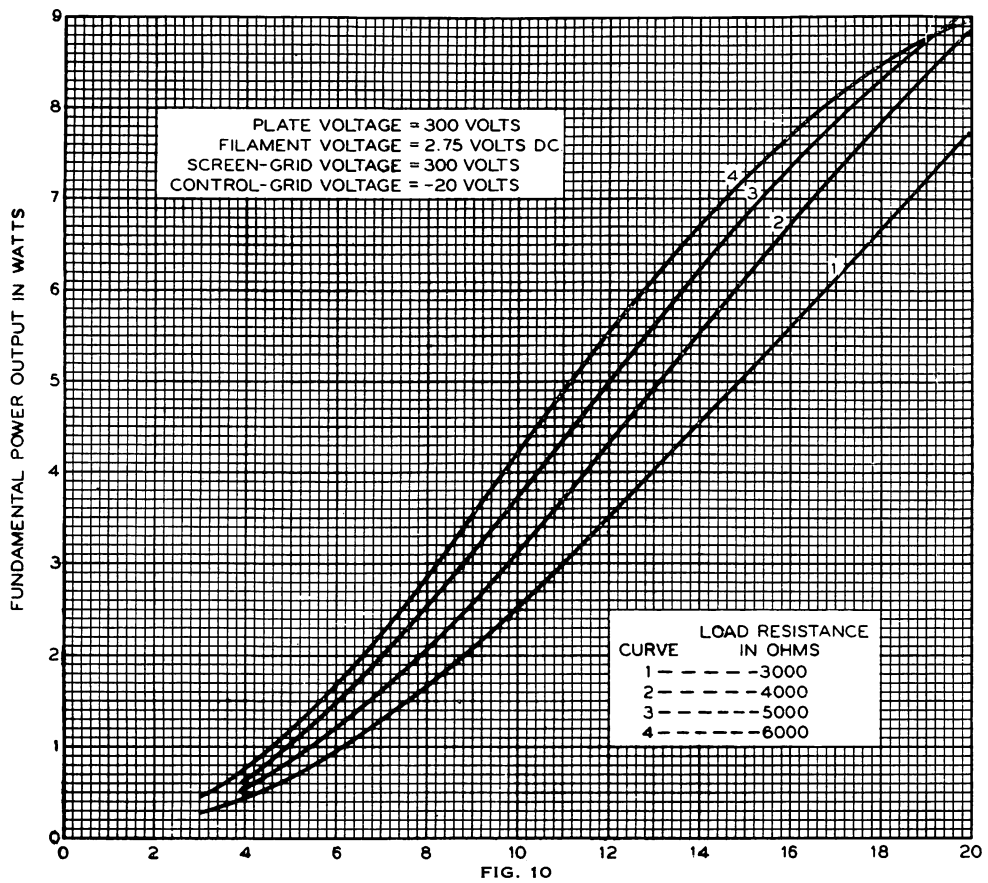

FIG. 9





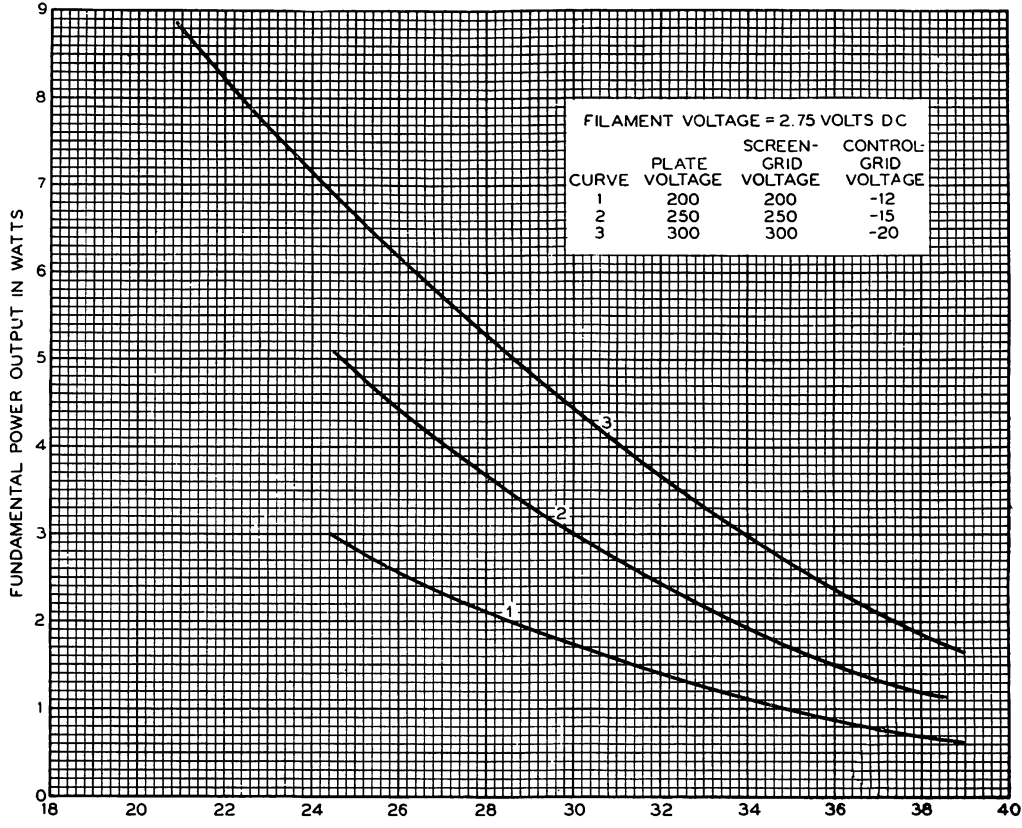

FIG. 13

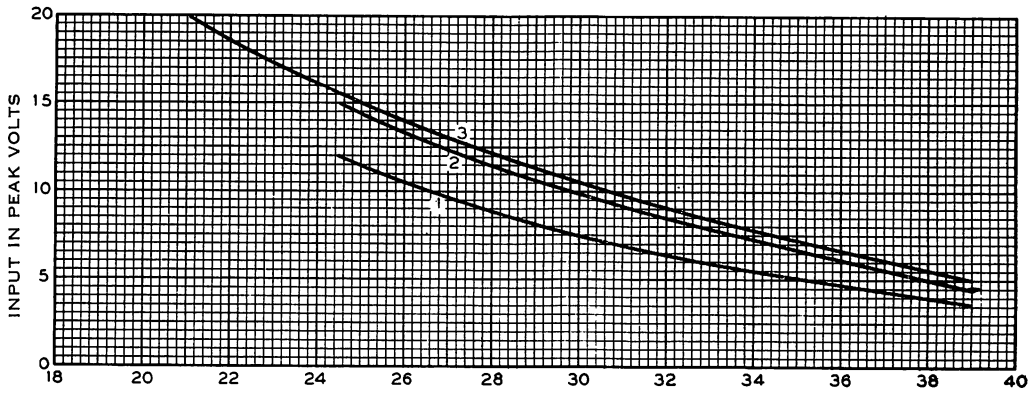

FIG. 14

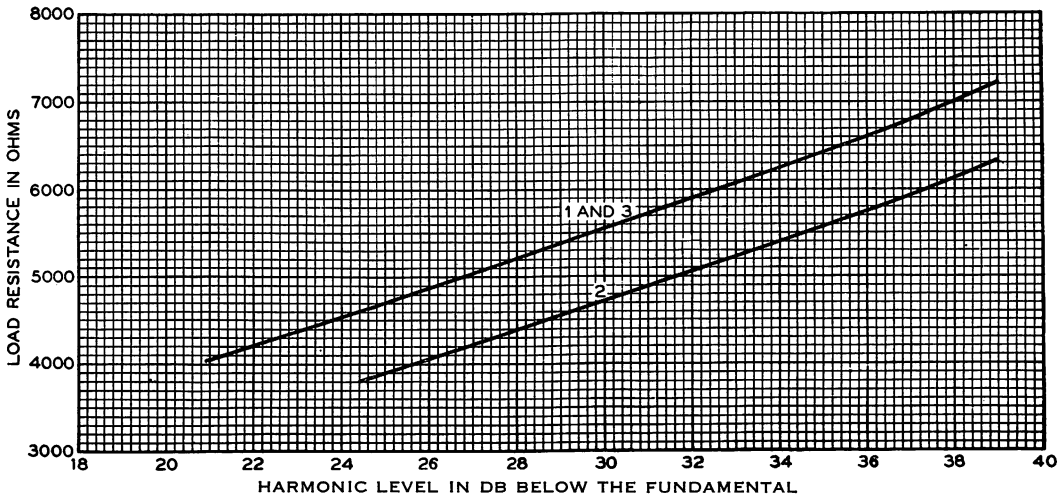

FIG. 15