



**TRIODE
AUDIO-FREQUENCY AMPLIFIER**

Western Electric

DESCRIPTION

The 101L is a filamentary type triode. It is designed for use as an audio-frequency amplifier or modulator.

CHARACTERISTICS

Filament Current	250 milliamperes
Maximum Plate Voltage	180 volts
Amplification Factor	6.5

GENERAL CHARACTERISTICS

ELECTRICAL DATA

Filament Current	250 milliamperes
Filament Voltage, Nominal*	4.15 volts
Direct Interelectrode Capacitances	without external shield
Grid to Plate	6.0 uuf
Input	3.9 uuf
Output	2.8 uuf

MECHANICAL DATA

Cathode	Coated Filament
Base	Medium 4-pin type with bayonet pin
Mounting Position	Preferably vertical; if horizontal, pins #1 and #2 must lie in same vertical plane

Dimensions and pin connections shown in outline drawing on Page 5

MAXIMUM RATINGS, Design-Center Values

Plate Voltage	180 volts
Plate Dissipation	2.0 watts
Plate Current	15 milliamperes

TYPICAL OPERATING CONDITIONS AND CHARACTERISTICS—CLASS A₁ AMPLIFIER

Filament Current, D-C	250	250 milliamperes
Plate Voltage	130	160 volts
Grid Voltage	-8	-10 volts
Peak A-F Grid Voltage	8	10 volts
Plate Current	6.8	10.2 milliamperes
Transconductance	1080	1240 micromhos
Amplification Factor	6.5	6.5
Plate Resistance	6000	5200 ohms
Load Resistance	6000	5200 ohms
Maximum Signal Power Output	60	100 milliwatts
Total Harmonic Distortion Less Than	3.4	3.2 per cent

* The filament resistance of this tube increases slightly during the first year of operating life. The voltage given above is the nominal value after the filament resistance has stabilized.

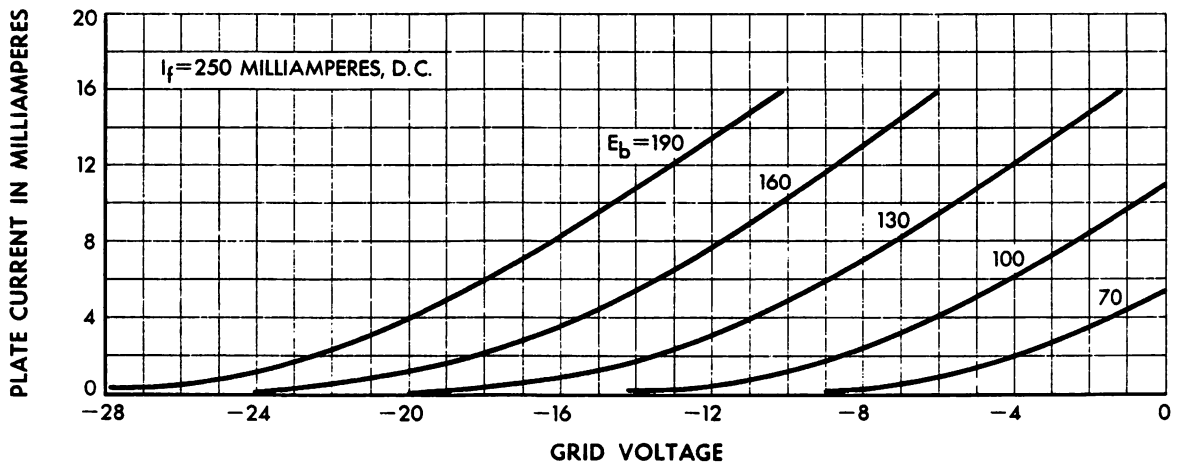
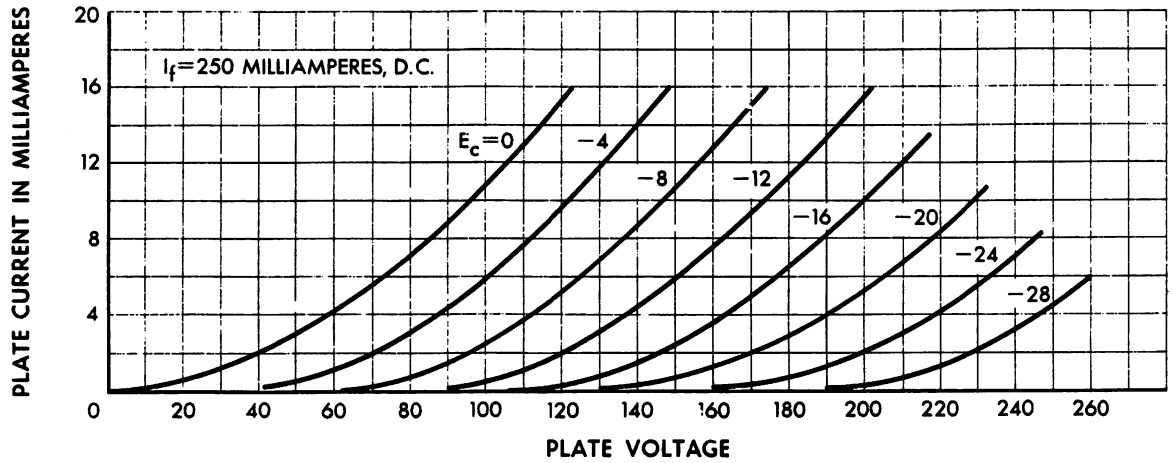

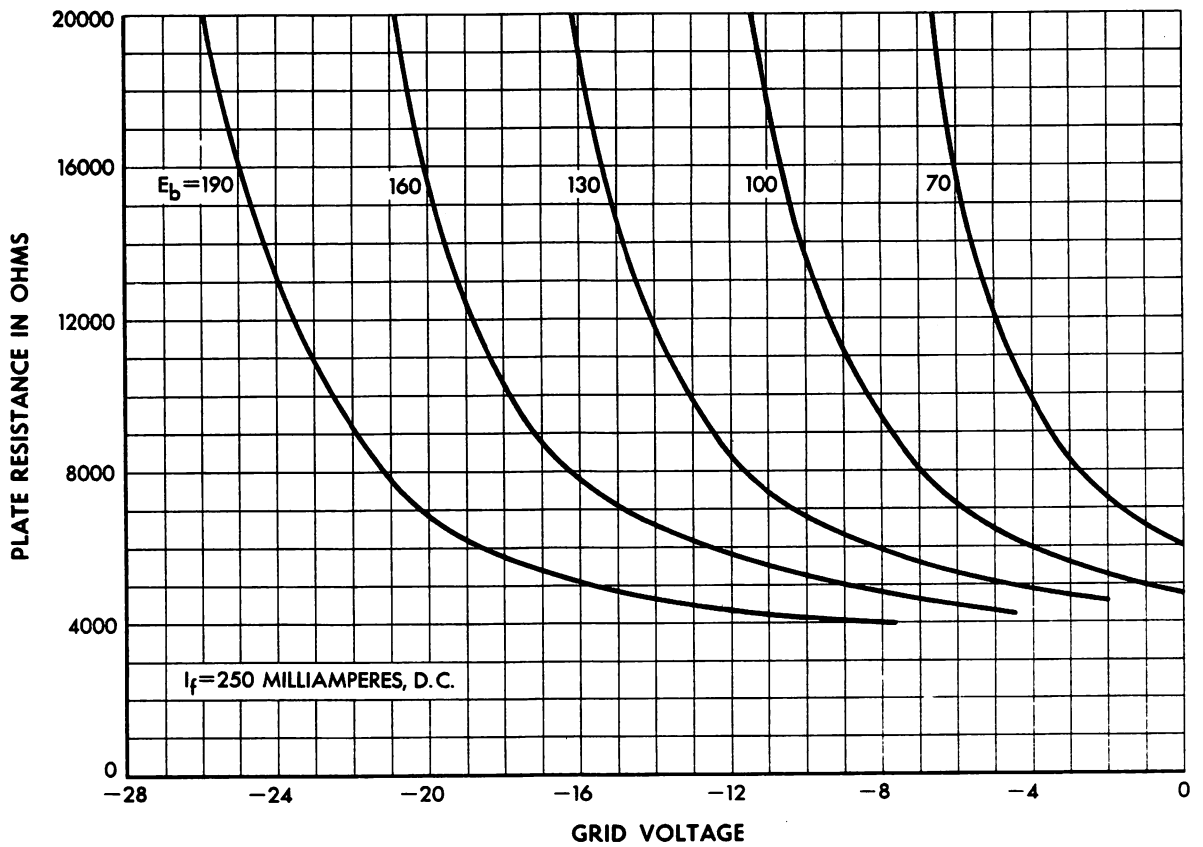
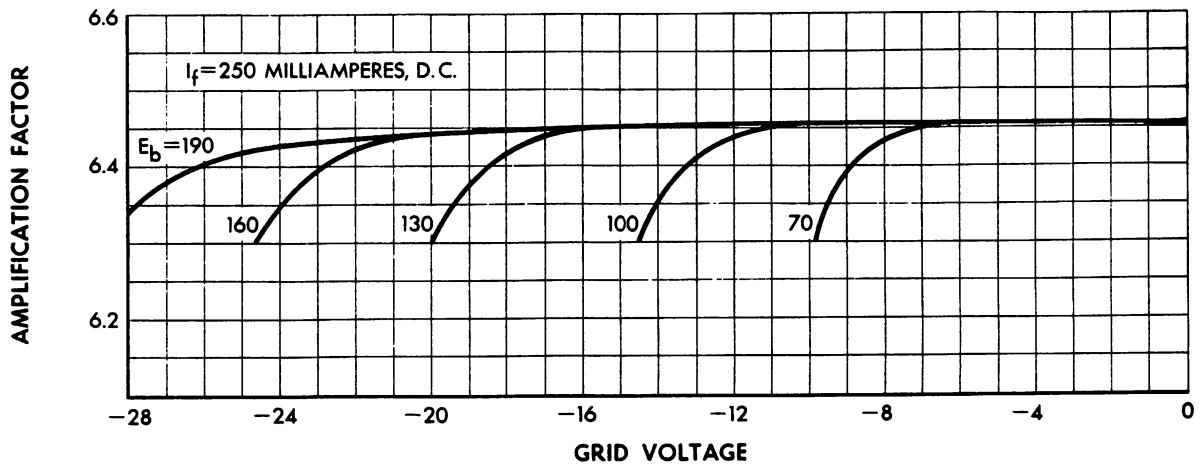

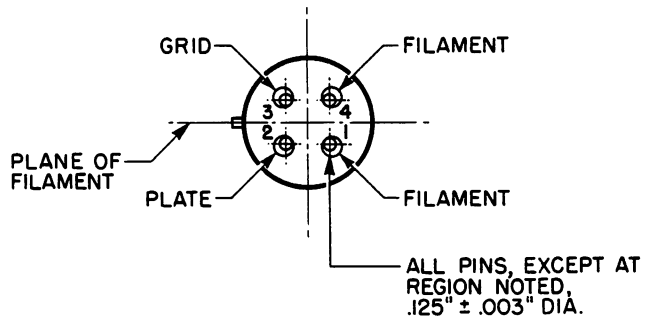
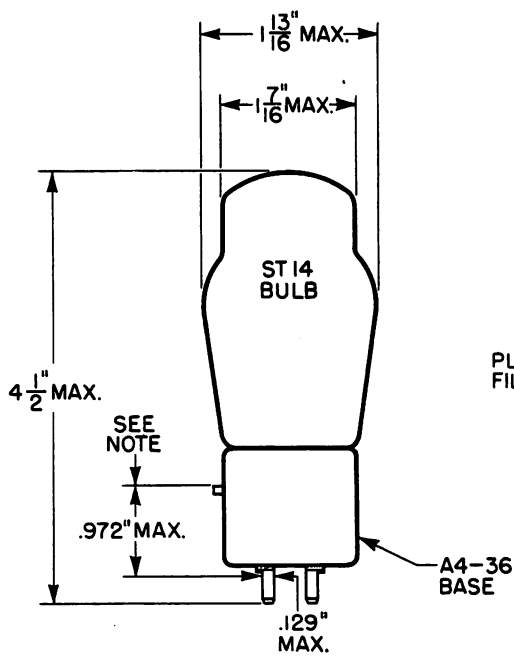
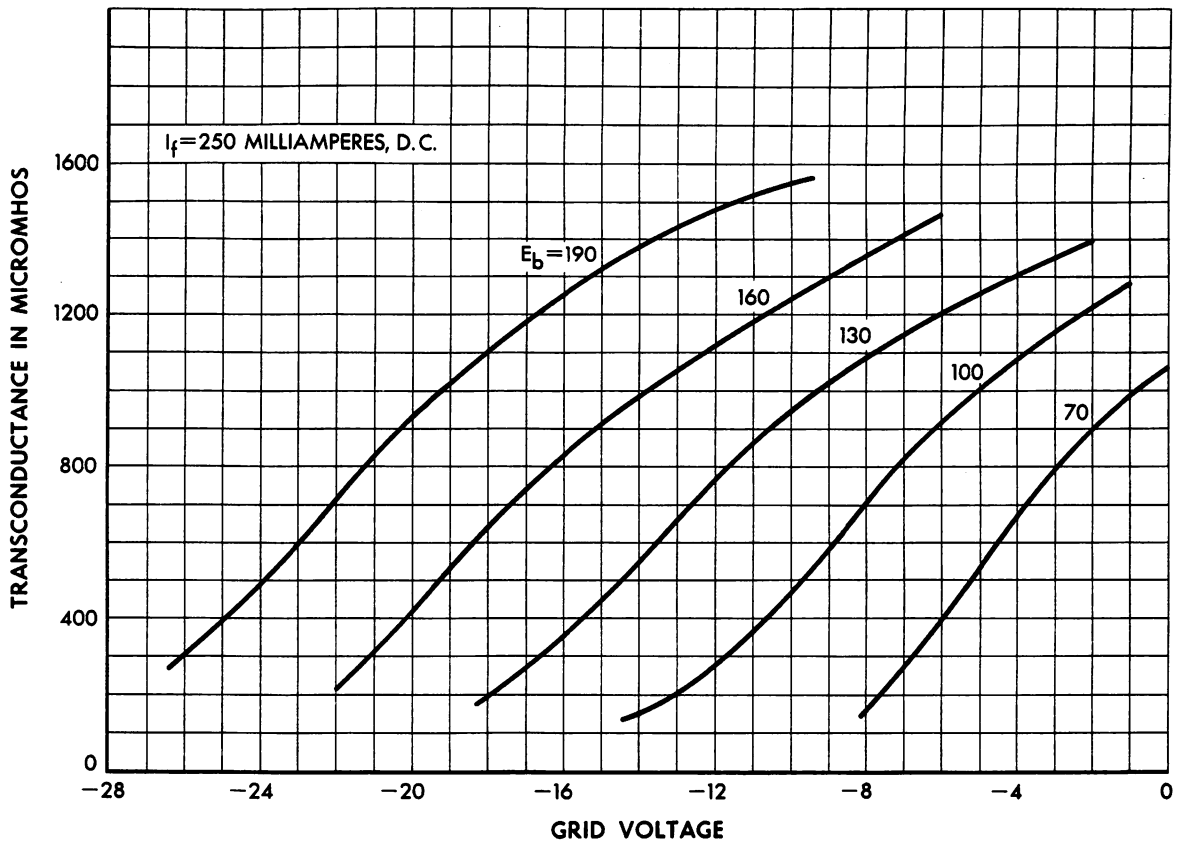

NOTE:
 THIS DIMENSION APPLIES FROM THE TOP OF THE BAYONET PIN, TO A POINT ON THE STUD WHERE THE DIAMETER OF THE STUD PLUS SOLDER DOES NOT EXCEED $.129$ MAX.

Western Electric

A development of Bell Telephone Laboratories, the research laboratories of the American Telephone and Telegraph Company and the Western Electric Company.